



BREAKERS & ATTACHMENTS

BREAKER MODEL

365 TN

OUR PERFORMANCE LINE

Piston Design

It has a perfect piston design and with its higher impact frequency, it is suitable for vertical and horizontal operations.

Membrane and Accumulator

With its highly resilient accumulator and membrane, our breakers impact with the same energy on every single stroke, thus providing maximum efficiency even when working on the hardest materials.

MORE DURABLE

C-Type Chassis

Its outer design is completely different and is supported with wearing-resistant Hardox® plates. C-type housing provides maximum durability even in the toughest conditions.

Wearing Plates

Our breakers have longer lifetimes thanks to their highly resilient tall type wearing plates which were specially designed for the toughest operating conditions.

Dual Retainers

Dual retainer design makes sure that the tool impacts with more balance.

MORE RELIABLE

Tie-rods

Our tie-rods are suitable for the harsh conditions of the tunnel environment and they make long and uninterrupted operation possible.

Minimum Vibration

Minimum vibration and maximum performance with our excellent impact absorbant vibration buffers and polyurethane-covered tie-rods.

Hydraulic Cushioning

If the breaker blank-fires during operation, thanks to our hydraulic cushioning feature the piston won't hit the cylinder, therefore prolonging the lifetimes of the components.



TECHNICAL INFORMATION

365 TN

Operating weight (a) kg	4050
Oil Flow l/min	220~270
Impact Rate (b) bpm	370~450
Operating Pressure (c) bar	145~150
Input power (d) kW	53.2~67.5
Relief Pressure bar	210
Back Pressure Max. bar	8
Tool Diameter mm	175
Noise Level (e) LWA (dB)	129
Carrier Weight (f) t	45~55

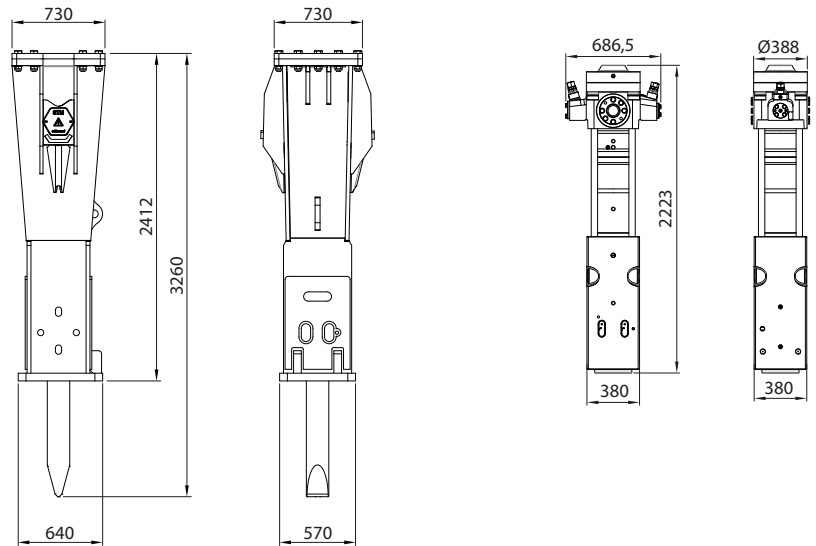

(a) It includes the approximate weight of the breaker, bracket, standard tool and hose weights.

(b) Actual impact frequency depends on the oil flow, oil viscosity, temperature and the material to be broken.

(c) Actual pressure depends on the oil flow, oil viscosity, temperature, material to be broken and the return pressure.

(d) Input power directly effects fuel consumption. Low input power (kW) requirement means low fuel consumption.

(e) Guaranteed sound power testing results according to directive 2000/14/EC (Guaranteed dB(A)=Measured Value +3 dB).

(f) If the carrier machine is out of the optimum range, ask the carrier machine manufacturer for allowed attachment weight.

TOOL PROPERTIES

	Pyramid	Moil	Chisel	Blunt
Operating Principle				
Key Properties	Breaking in four directions General demolition	Breaking in all directions Suitable for general use	Breaking in two directions Suitable for general purpose by demolition	Good energy transfer Demolition – Impact breaking

SPECIAL TOOLS

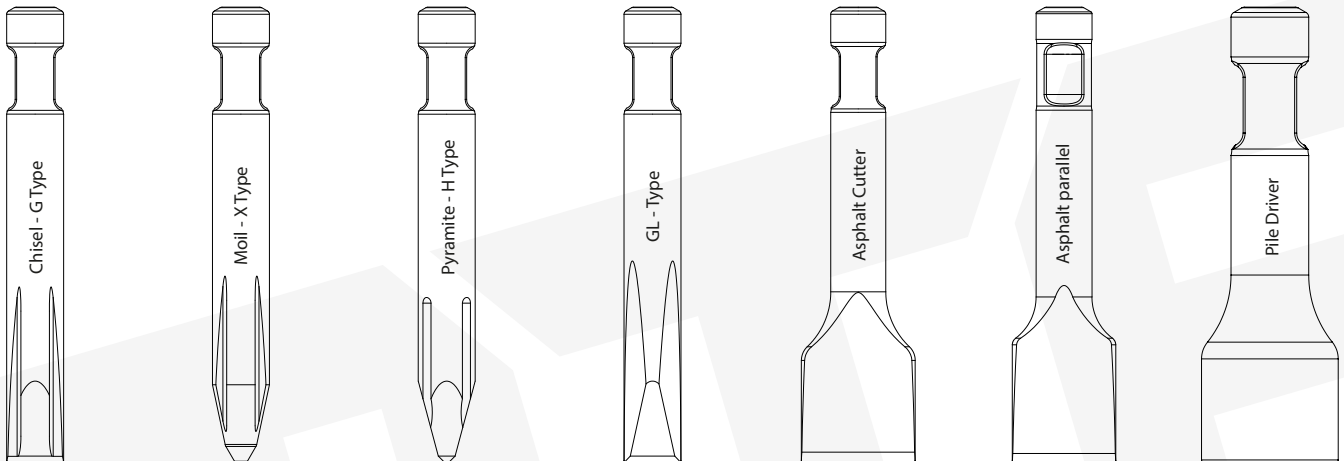

Rev. 18072023



Factory
Bahçelievler OSB Mh. 11. Cd. No: 4A
59510 Kapaklı / Tekirdağ - TURKEY
+90 282 768 25 00
www.mtbbreakers.com - info@inanmakina.com



WARNING!: The visuals and the information in this brochure are standard or optional depending on the version of the product.

INAN MAKİNA A.Ş. saves the right to modify the values and designs shown in this brochure without notice.